

# TEVA

## Zipper information



Teva-Team Oy  
Kaarningonkatu 17  
20740 Turku  
Finland

Tel. +358 2 2737 900  
[myynti@teva-team.fi](mailto:myynti@teva-team.fi)  
[www.teva-team.fi](http://www.teva-team.fi)



## Zipper function

### One Way Fasteners

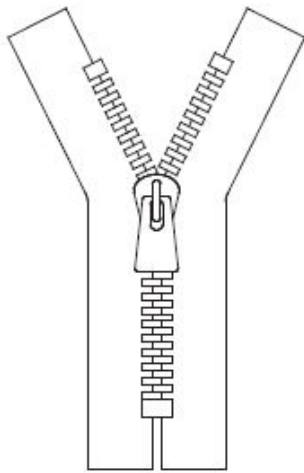

Closed End - Standard

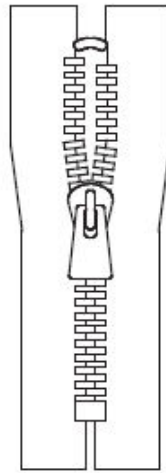

Closed End - Alternative

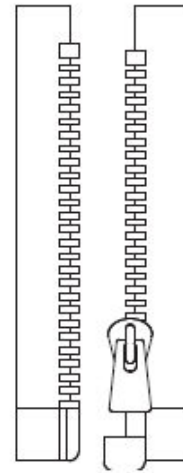

Open End

### Two Way Fasteners

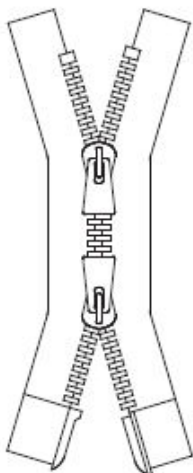

2-Way Open End

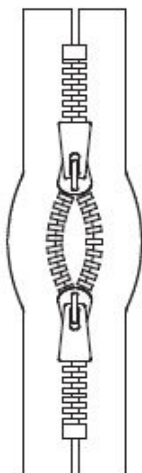

"O" Type

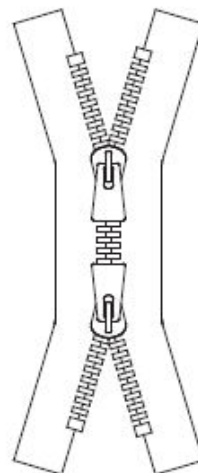

"X" Type

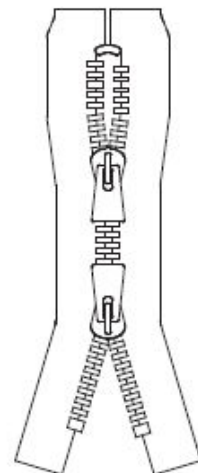

"R" Type



## Zipper measuring

Dimension tolerance

Dimension	Maximum tolerance
3cm-6 cm	+ - 10mm
6cm-12cm	+ - 15mm
12cm-99cm	+ - 2%
100cm-999cm	+ - 1%

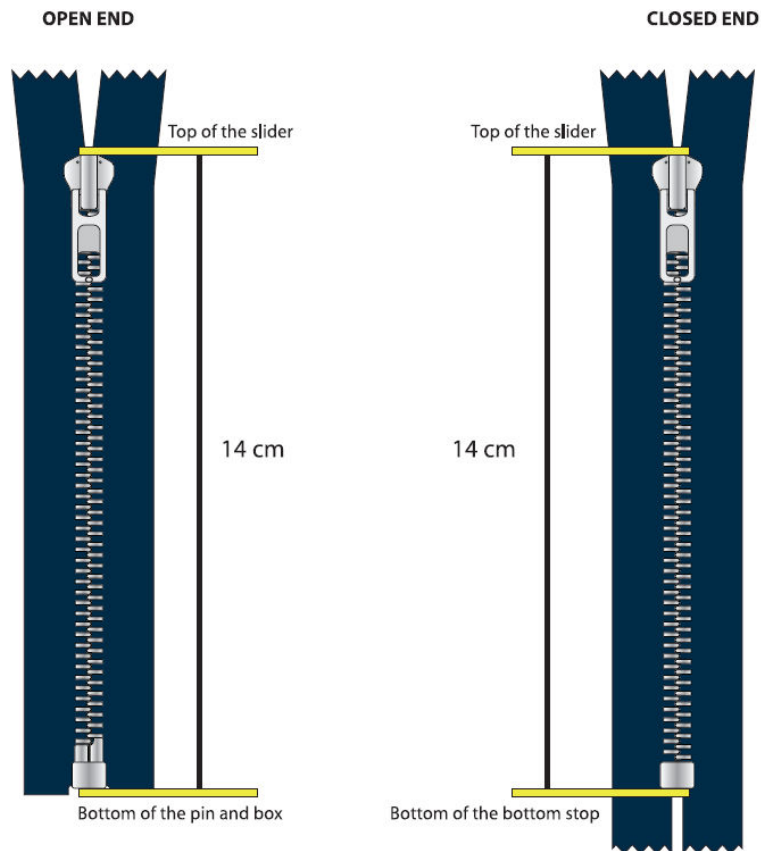



## Zipper strength

### BS EN 16732:2015 Performance Requirements of Slide Fasteners According to End Use

The following table sets out the basic minimum requirements for zipper performance according to end use.

Annex		Performance Code					
		Unit	A	B	C	D	E
B	Strength of puller attachment (min.)	N	70	80	200	250	300
C	Strength of closed-end (min.)	N	35	60	80	100	140
D	Strength of top stop (min.)	N	50	70	90	110	130
E	Strength of open-end slide fastener box (min.)	N	40	70	90	120	150
F	Resistance to reciprocation: Minimum cycles without failure	Cycles	500	500	500	500	500
G	Lateral strength of slide fastener (min.)	N	150	200	250	370	470
H	Lateral strength of open-end attachment (min.)	N	50	70	90	120	160
I	Strength of slider locking device (min.)	N	10	15	25	40	60

As a general rule of thumb, the following table can be used as a guideline in selecting the correct gauge of zipper for a particular performance code.

Zipper Type	Performance Code				
	A	B	C	D	E
Metal	#3	#3/#4	#4/#5	#5/#8	#8/#10
Coil	#3	#3/#4	#5	#8	#8/#10
Plastic	#3	#3	#5	#8	#8/#10
Invisible	#3	#3/#4	#5	-	-



## Invisible zipper sewing information

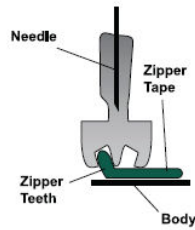
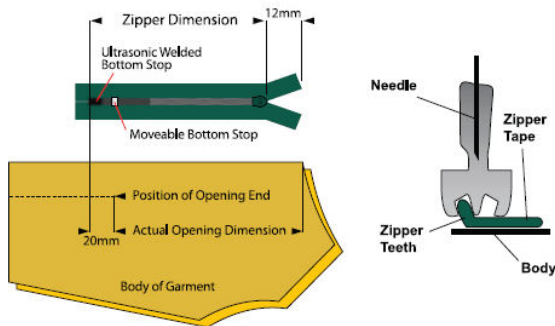

Use a zipper that is 2cm longer than the actual opening length of the garment

- (1) Place A and B together and sew the opening end. Reverse stitch at the opening end position then mark the position of the opening end for A and B.
- (2) Place A and B together along with the zipper and mark the zipper at the corresponding position in relation to the opening end.
- (3) Pull the slider to the bottom stop and sew one side of the zipper whilst checking that marks on the zipper line up with the body. Using the SLIK sewing foot, raise the zipper elements inserting them in to the grooves and sew.
- (4) Be careful not to cross the stitching on the opening end position with the stitching on the zipper. Leave enough space for the puller to pass through. Sew the zipper and body together to the opening end position and reverse stitch at both ends of the zipper.
- (5) After sewing the zipper on left and right bodies, pull the puller through to the front side and close the zipper.
- (6) Adjust the moveable bottom stop about 5mm upwards from the opening and clamp - the moveable bottom stop will prevent fraying at the opening end.

# TEVA

## Zip type

### Coil Zipper



	CLOSE END	OPEN END	TWO WAY	LONG CHAIN	REVERSE	AUTOLOCK	5P	3P	HOOK TYPE	FLAT TYPE	NONLOCK	SEMILOCK
N3 NYLON	X	X		X	X	X	X	X	X	X	X	X
N5 NYLON	X	X	X	X	X	X	X	X	X	X	X	X
N7 NYLON	X	X	X	X	X	X					X	X
N8 NYLON	X	X	X	X		X	X	X	X	X	X	
N10 NYLON	X	X		X							X	



N3/4mm



N5/6mm



N7/6,4mm

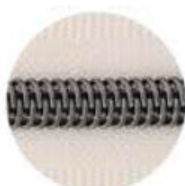

N8/8mm



N10/10mm





## Zip type

### *Coil water repellent zipper*



	CLOSE END	OPEN END	TWO WAY	LONG CHAIN	REVERSE	AUTOLOCK	5P	3P	HOOK TYPE	FLAT TYPE	NONLOCK	SEMILOCK
N3 wr NYLON	X	X		X		X	X	X	X	X	X	X
N5 wr NYLON	X	X	X	X		X	X	X	X	X	X	X

- available with matt and shiny version

### *Coil water repellent and printed zipper*



	CLOSE END	OPEN END	TWO WAY	LONG CHAIN	REVERSE	AUTOLOCK	5P	3P	HOOK TYPE	FLAT TYPE	NONLOCK	SEMILOCK
N3 wr NYLON	X	X		X		X	X	X	X	X	X	X
N5 wr NYLON	X	X	X	X		X	X	X	X	X	X	X

- Available with matt and shiny version

Teva-Team Oy  
Kaarningonkatu 17  
20740 Turku  
Finland

Tel. +358 2 2737 900  
myynti@teva-team.fi  
www.teva-team.fi

# TEVA

## Zip type

*Coil water repellent colored foil*



- Matt



- Shiny

	CLOSE END	OPEN END	TWO WAY	LONG CHAIN	REVERSE	AUTOLOCK	5P	3P	HOOK TYPE	FLAT TYPE	NONLOCK	SEMILOCK
N3 wr NYLON	X	X		X		X	X	X	X	X	X	X
N5 wr NYLON	X	X	X	X		X	X	X	X	X	X	X



# TEVA

## Zip type

### Coil Zipper with reflective tape



	CLOSE END	OPEN END	TWO WAY	LONG CHAIN	REVERSE	AUTOLOCK	5P	3P	HOOK TYPE	FLAT TYPE	NONLOCK	SEMILOCK
N3 NYLON	X	X		X	X	X	X	X	X	X	X	X
N5 NYLON	X	X	X	X	X	X	X	X	X	X	X	X
N7 NYLON	X	X	X	X	X	X					X	X
N8 NYLON	X	X	X	X		X	X	X	X	X	X	
N10 NYLON	X	X		X							X	

### Invisible coil zipper

- 13/4mm
- 14/5mm
- 15/6mm
- Lace and woven tape



13/4mm



14/5mm



15/6mm



## Zip type

*Coil Zipper with special weaving tape and painted slider and puller*



*Coil Zipper stops*



Metal stops



Film top stop



Plastic top stop



Metal stop



Film stop



Metal pin box



Plastic pin box



Plastic pin to pin



Metal Pin to Pin



## Zip type

### *Metallic coil zipper*

- N3/4mm
- N5/6mm
- N8/8mm long chain
- N10/10mm long chain



Silver



Gun Metal



Gold



Antique

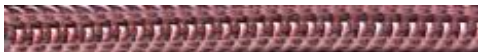

Copper



Rainbow



Black Free Nickel



Light Gold



Rose Gold



Oxide



Neon

	CLOSE END	OPEN END	TWO WAY	LONG CHAIN	REVERSE	AUTOLOCK	5P	3P	HOOK TYPE	FLAT TYPE	NONLOCK
N3 Metal NYLON	x	x		x		x	x	x	x	x	x
N5 Metal NYLON	x	x	x	x		x	x	x	x	x	x



## Zip type

*Delrin (plastic) zipper*



	CLOSE END	OPEN END	TWO WAY	LONG CHAIN	REVERSE	AUTOLOCK	5P	3P	HOOK TYPE	FLAT TYPE	NONLOCK	SEMILOCK	PLASTIC ONE SIDE	PLASTIC TWO SIDE
DELFIN 3	X	X	X	X		X	X	X	X	X	X			
DELFIN 5	X	X	X	X		X	X	X	X	X	X		X	X
DELFIN 8	X	X	X	X		X	X	X	X	X	X			
DELFIN 10	X	X	X	X		X	X	X	X	X	X		X	X



D3/4mm



D5/6mm



D8/8mm



D10/9mm



D5/6mm Jaws



D7/7mm Jaws

Teva-Team Oy  
Kaarningonkatu 17  
20740 Turku  
Finland

Tel. +358 2 2737 900  
myynti@teva-team.fi  
www.teva-team.fi



## Zip type

*Delrin (plastic) water repellent zipper*



- Shiny and matte version available

	CLOSE END	OPEN END	TWO WAY	LONG CHAIN	REVERSE	AUTOLOCK	5P	3P	HOOK TYPE	FLAT TYPE	NONLOCK
DELIRIN 3	X	X	X	X		X	X	X	X	X	X
DELIRIN 5	X	X	X	X		X	X	X	X	X	X

*Delrin (plastic) quick release zipper*



	CLOSE END	OPEN END	TWO WAY	LONG CHAIN	REVERSE	AUTOLOCK	5P	3P	HOOK TYPE	FLAT TYPE	NONLOCK
DELIRIN 3	X	X				X	X	X			
DELIRIN 5	X	X				X	X	X			
DELIRIN 8	X	X				X	X	X			

Teva-Team Oy  
Kaarningonkatu 17  
20740 Turku  
Finland

Tel. +358 2 2737 900  
myynti@teva-team.fi  
www.teva-team.fi



## Zip type

*Delrin (plastic) metallic imitation teeth*

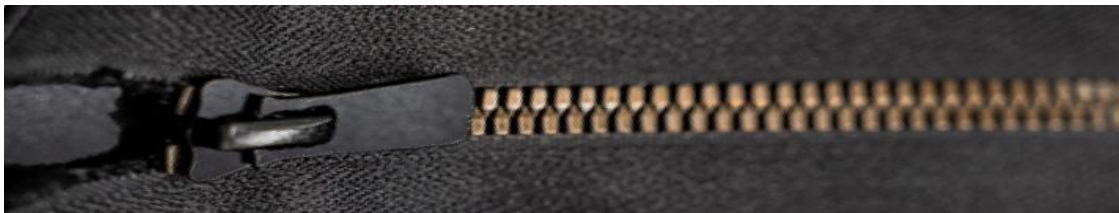

- D3/4mm
- D5/6mm
- D8/8mm



D3/4mm



D5/6mm

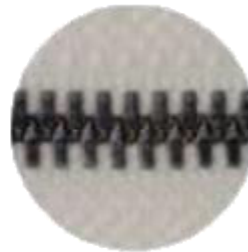

D8/8mm



# TEVA

## *Delrin (plastic) metallic teeth colors*



Antique



Copper



Gold



Shiny Black



Shiny Silver



Transparent



Oxide



Gun Metal



Silver



Shiny Gold



Neon

## *Delrin (plastic) stops*



Plastic top stop



Plastic stop



Plastic pim box



Plastic pim



## Zip type

### Metal zipper



	CLOSE END	OPEN END	TWO WAY	LONG CHAIN	REVERSE	AUTOLOCK	5P	3P	HOOK TYPE	FLAT TYPE	NONLOCK	SEMILOCK
METAL 2	X	X		X				X	X	X		
METAL 3	X	X	X	X		X	X	X	X	X	X	X
METAL 5	X	X	X	X		X	X	X	X	X	X	X
METAL 8	X	X	X	X		X	X	X	X	X	X	X
METAL 10	X	X				X		X				
METAL 15	X	X						X				



M2/3,7mm



M3/4,5mm



M5/6mm



M8/8mm



M10/9mm



M15/12,6mm

Teva-Team Oy  
 Kaarningonkatu 17  
 20740 Turku  
 Finland

Tel. +358 2 2737 900  
 myynti@teva-team.fi  
 www.teva-team.fi



## Zip type

*Metal zipper Quick release + Aramide tape for high temperature*



	CLOSE END	OPEN END	TWO WAY	LONG CHAIN	REVERSE	AUTOLOCK	5P	3P
METAL 5		X				X	X	X
METAL 8		X				X	X	X

*Metal zipper Aramide tape for high temperature*



	CLOSE END	OPEN END	TWO WAY	LONG CHAIN	REVERSE	AUTOLOCK	5P	3P	HOOK TYPE	FLAT TYPE	NONLOCK	SEMILOCK
METAL 2	X	X		X				X	X	X		
METAL 3	X	X	X	X		X	X	X	X	X	X	X
METAL 5	X	X	X	X		X	X	X	X	X	X	X
METAL 8	X	X	X	X		X	X	X	X	X	X	X

Teva-Team Oy  
 Kaarningonkatu 17  
 20740 Turku  
 Finland

Tel. +358 2 2737 900  
 myynti@teva-team.fi  
 www.teva-team.fi



## Zip type

*Metal zipper with symmetric teeth*



M4/4,5mm



M5/6mm



M8/8mm

	CLOSE END	OPEN END	TWO WAY	LONG CHAIN	REVERSE	AUTOLOCK	5P	3P	HOOK TYPE	FLAT TYPE	NONLOCK	SEMILOCK
METAL 4	X	X	X	X		X	X	X	X	X	X	X
METAL 5	X	X	X	X		X	X	X	X	X	X	X
METAL 8	X	X	X	X		X	X	X	X	X	X	X

*Metal zipper stops*



Metal top stops



Metal stop



Metal pim box



Metal pims





## Zip type

*Metal zipper teeth colors*

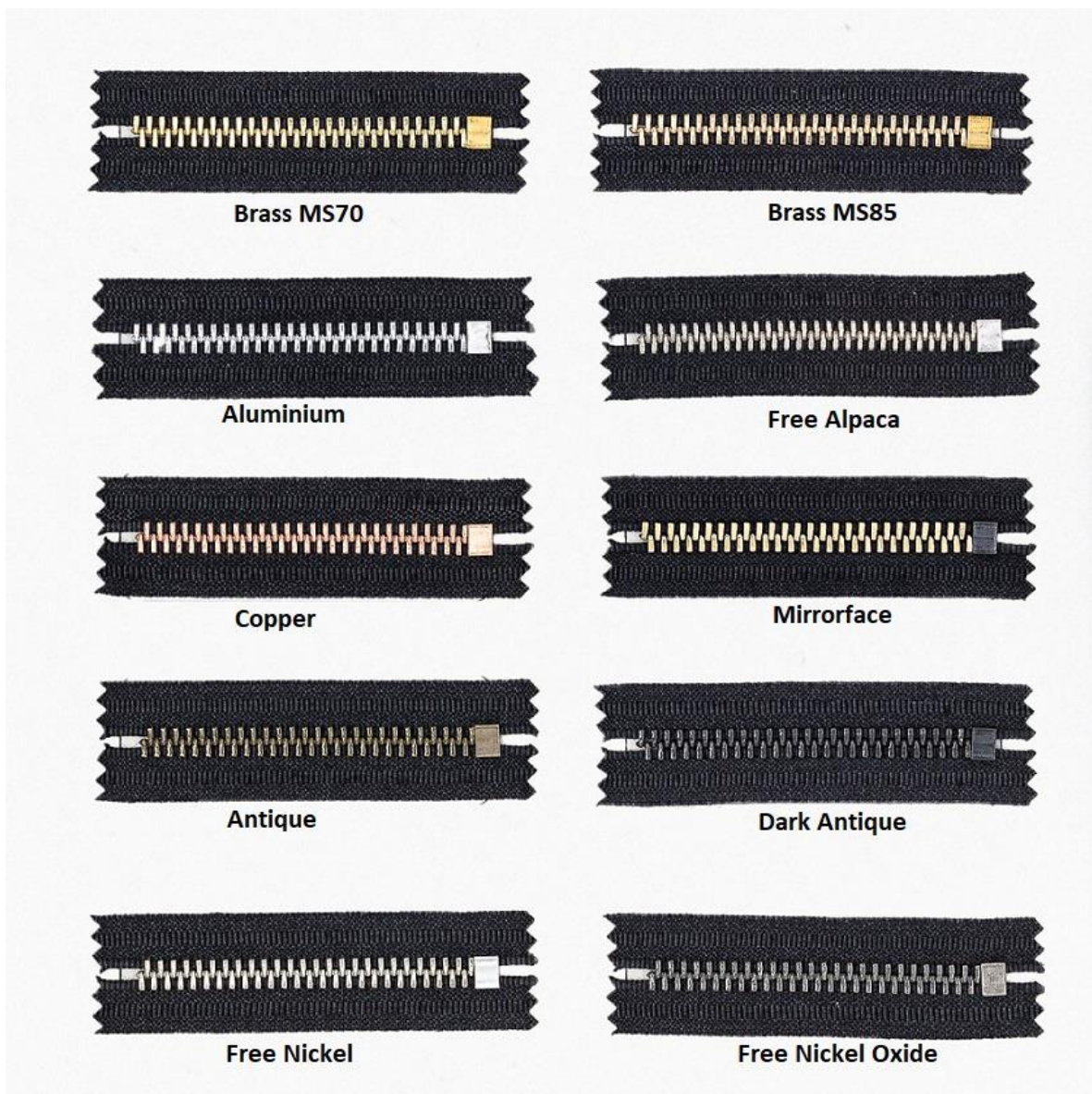

Teva-Team Oy  
Kaarningonkatu 17  
20740 Turku  
Finland

Tel. +358 2 2737 900  
myynti@teva-team.fi  
www.teva-team.fi



## Zip type

*Metal zipper teeth colors*



Teva-Team Oy  
Kaarningonkatu 17  
20740 Turku  
Finland

Tel. +358 2 2737 900  
myynti@teva-team.fi  
www.teva-team.fi



# TEVA

## Tape woven types



TP 1001



TP 1002



TP 1003



TP 1004



TP 1005



TP 1006



TP 1007



TP 1008



TP 1009



TP 1010



TP 1011



TP 1012



TP 1013



TP 1014



TP 1015



TP 1016



TP 1017



TP 1018



TP 1019



TP 1020



## Slider types

Auto-lock	size	Coil	Delrin	Metal
	4mm	*	*	*
	6mm	*	*	*
	6,5mm	*		*
	8mm	*	*	*
	9mm	*	*	*
	10mm			*
	12,5mm			

Non-lock	size	Coil	Delrin	Metal
	4mm	*	*	*
	6mm	*	*	*
	6,5mm	*		*
	8mm	*	*	*
	9mm	*	*	*
	10mm	*		*
	12,5mm			*

Link (type ME)	size	Coil	Delrin	Metal
	4mm	*	*	*
	6mm	*	*	*
	6,5mm	*		*
	8mm	*	*	*
	9mm	*	*	*
	10mm			
	12,5mm			

Hook (type KE)	size	Coil	Delrin	Metal
	4mm	*	*	*
	6mm	*	*	*
	6,5mm	*		*
	8mm	*	*	*
	9mm	*	*	*
	10mm			
	12,5mm			

Wired	size	Coil	Delrin	Metal
	4mm	*	*	*
	6mm	*	*	*
	6,5mm	*		*
	8mm	*	*	*
	9mm	*	*	*
	10mm	*		*
	12,5mm			*

Reversible	size	Coil	Delrin	Metal
	4mm	*		
	6mm	*	*	*
	6,5mm			
	8mm	*	*	
	9mm		*	
	10mm			
	12,5mm			

Two way non-lock	size	Coil	Delrin	Metal
	4mm	*		
	6mm	*	*	*
	6,5mm	*		*
	8mm	*	*	*
	9mm		*	*
	10mm	*		*
	12,5mm			*

Semi-lock	size	Coil	Delrin	Metal
	4mm	*		*
	6mm	*		*
	6,5mm	*		
	8mm	*		*
	9mm			
	10mm			
	12,5mm			

Semi-lock	size	Coil	Delrin	Metal
	4mm	*		*
	6mm	*		*
	6,5mm	*		
	8mm	*		*
	9mm			
	10mm			
	12,5mm			

# TEVA

## Slider metal imitation and hanger plating

### Barrel Finishes



2F

Silver



6F

Dark silver



9F

Eco Black



14F

Dark antique brass



21F

Antique silver



25F

Gold



26F

Brass



35F

Antique brass



42F

Shiny copper

### Hanger plating finishes



52H

Copper



53H

Silver



60H

Dull silver



64H

Brass



65H

Shiny gold



61B

Antique brass



67H

Eco black



72H

Dull gold



79P

rubber touch black



84P

Neon pink



91P

Neon yellow